





TX-497

Stereo Tuner

OWNER'S MANUAL

IMPORTANT SAFETY INSTRUCTIONS

	CAUTION RISK OF ELECTRIC SHOCK DO NOT OPEN	
<p>CAUTION: TO REDUCE THE RISK OF ELECTRIC SHOCK, DO NOT REMOVE COVER (OR BACK). NO USER-SERVICEABLE PARTS INSIDE. REFER SERVICING TO QUALIFIED SERVICE PERSONNEL.</p>		

• Explanation of Graphical Symbols



The lightning flash with arrowhead symbol, within an equilateral triangle, is intended to alert you to the presence of uninsulated “dangerous voltage” within the product’s enclosure that may be of sufficient magnitude to constitute a risk of electric shock to persons.



The exclamation point within an equilateral triangle is intended to alert you to the presence of important operating and maintenance (servicing) instructions in the literature accompanying the appliance.

Note to CATV system installer:

This reminder is provided to call the CATV system installer’s attention to Article 820-40 of the NEC that provides guidelines for proper grounding and, in particular, specifies that the cable ground shall be connected to the grounding system of the building, as close to the point of cable entry as practical.

IMPORTANT

Please record the serial number of this unit in the space below.

MODEL:

Serial No.:

The serial number is located on the rear of the unit.

Retain this Owner’s Manual in a safe place for future reference.

- 1 Read these instructions.
- 2 Keep these instructions.
- 3 Heed all warnings.
- 4 Follow all instructions.
- 5 Do not use this apparatus near water.
- 6 Clean only with dry cloth.
- 7 Do not block any ventilation openings. Install in accordance with the manufacturer’s instructions.
- 8 Do not install near any heat sources such as radiators, heat registers, stoves, or other apparatus (including amplifiers) that produce heat.
- 9 Do not defeat the safety purpose of the polarized or grounding-type plug. A polarized plug has two blades with one wider than the other. A grounding type plug has two blades and a third grounding prong. The wide blade or the third prong are provided for your safety. If the provided plug does not fit into your outlet, consult an electrician for replacement of the obsolete outlet.
- 10 Protect the power cord from being walked on or pinched particularly at plugs, convenience receptacles, and the point where they exit from the apparatus.
- 11 Only use attachments/accessories specified by the manufacturer.
- 12 Use only with the cart, stand, tripod, bracket, or table specified by the manufacturer, or sold with the apparatus. When a cart is used, use caution when moving the cart/apparatus combination to avoid injury from tip-over. 
- 13 Unplug this apparatus during lightning storms or when unused for long periods of time.
- 14 Refer all servicing to qualified service personnel. Servicing is required when the apparatus has been damaged in any way, such as power-supply cord or plug is damaged, liquid has been spilled or objects have fallen into the apparatus, the apparatus has been exposed to rain or moisture, does not operate normally, or has been dropped.

We Want You Listening For A Lifetime

YAMAHA and the Electronic Industries Association’s Consumer Electronics Group want you to get the most out of your equipment by playing it at a safe level. One that lets the sound come through loud and clear without annoying blaring or distortion – and, most importantly, without affecting your sensitive hearing. Since hearing damage from loud sounds is often undetectable until it is too late, YAMAHA and the Electronic Industries Association’s Consumer Electronics Group recommend you to avoid prolonged exposure from excessive volume levels.



FCC INFORMATION (for US customers)

1 **IMPORTANT NOTICE: DO NOT MODIFY THIS UNIT!**

This product, when installed as indicated in the instructions contained in this manual, meets FCC requirements. Modifications not expressly approved by Yamaha may void your authority, granted by the FCC, to use the product.

2 **IMPORTANT:** When connecting this product to accessories and/or another product use only high quality shielded cables. Cable/s supplied with this product **MUST** be used. Follow all installation instructions. Failure to follow instructions could void your FCC authorization to use this product in the USA.

3 **NOTE:** This product has been tested and found to comply with the requirements listed in FCC Regulations, Part 15 for Class "B" digital devices. Compliance with these requirements provides a reasonable level of assurance that your use of this product in a residential environment will not result in harmful interference with other electronic devices.

This equipment generates/uses radio frequencies and, if not installed and used according to the instructions found in the users manual, may cause interference harmful to the operation of other electronic devices.

Compliance with FCC regulations does not guarantee that interference will not occur in all installations. If this product is found to be the source of interference, which can be determined by turning the unit "OFF" and "ON", please try to eliminate the problem by using one of the following measures:

Relocate either this product or the device that is being affected by the interference.

Utilize power outlets that are on different branch (circuit breaker or fuse) circuits or install AC line filter/s.

In the case of radio or TV interference, relocate/reorient the antenna. If the antenna lead-in is 300 ohm ribbon lead, change the lead-in to coaxial type cable.

If these corrective measures do not produce satisfactory results, please contact the local retailer authorized to distribute this type of product. If you can not locate the appropriate retailer, please contact Yamaha Electronics Corp., U.S.A. 6660 Orangethorpe Ave, Buena Park, CA 90620.

The above statements apply **ONLY** to those products distributed by Yamaha Corporation of America or its subsidiaries.

CAUTION: READ THIS BEFORE OPERATING YOUR UNIT.

- 1 To assure the finest performance, please read this manual carefully. Keep it in a safe place for future reference.
- 2 Install this sound system in a well ventilated, cool, dry, clean place – away from direct sunlight, heat sources, vibration, dust, moisture, and/or cold. Allow ventilation space of at least 10 cm on the top, and 10 cm on the back of this unit.
- 3 Locate this unit away from other electrical appliances, motors, or transformers to avoid humming sounds.
- 4 Do not expose this unit to sudden temperature changes from cold to hot, and do not locate this unit in an environment with high humidity (i.e. a room with a humidifier) to prevent condensation inside this unit, which may cause an electrical shock, fire, damage to this unit, and/or personal injury.
- 5 Avoid installing this unit where foreign objects may fall onto this unit and/or this unit may be exposed to liquid dripping or splashing. On the top of this unit, do not place:
 - Other components, as they may cause damage and/or discoloration on the surface of this unit.
 - Burning objects (i.e. candles), as they may cause fire, damage to this unit, and/or personal injury.
 - Containers with liquid in them, as they may fall and liquid may cause electrical shock to the user and/or damage to this unit.
- 6 Do not cover this unit with a newspaper, tablecloth, curtain, etc. in order not to obstruct heat radiation. If the temperature inside this unit rises, it may cause fire, damage to this unit, and/or personal injury.
- 7 Do not plug in this unit to a wall outlet until all connections are complete.
- 8 Do not operate this unit upside-down. It may overheat, possibly causing damage.
- 9 Do not use force on switches, knobs and/or cords.
- 10 When disconnecting the power cable from the wall outlet, grasp the plug; do not pull the cable.
- 11 Do not clean this unit with chemical solvents; this might damage the finish. Use a clean, dry cloth.
- 12 Only voltage specified on this unit must be used. Using this unit with a higher voltage than specified is dangerous and may cause fire, damage to this unit, and/or personal injury. YAMAHA will not be held responsible for any damage resulting from use of this unit with a voltage other than specified.
- 13 To prevent damage by lightning, keep the power cord and outdoor antennas disconnected from a wall outlet or the unit during a lightning storm.
- 14 Do not attempt to modify or fix this unit. Contact qualified YAMAHA service personnel when any service is needed. The cabinet should never be opened for any reasons.
- 15 When not planning to use this unit for long periods of time (i.e. vacation), disconnect the AC power plug from the wall outlet.
- 16 Install this unit near the AC outlet and where the AC power plug can be reached easily.
- 17 Be sure to read the “TROUBLESHOOTING” section on common operating errors before concluding that this unit is faulty.
- 18 Before moving this unit, press POWER to set this unit in the standby mode, and disconnect the AC power plug from the wall outlet.
- 19 **VOLTAGE SELECTOR** (Asia and General models only)
The VOLTAGE SELECTOR on the rear panel of this unit must be set for your local main voltage BEFORE plugging into the AC main supply. Voltages are:
Asia and General models AC 110–120/220–240 V, 50/60 Hz

WARNING

TO REDUCE THE RISK OF FIRE OR ELECTRIC SHOCK, DO NOT EXPOSE THIS UNIT TO RAIN OR MOISTURE.

As long as this unit is connected to the AC wall outlet, it is not disconnected from the AC power source even if you turn off this unit by POWER.

FOR CANADIAN CUSTOMERS

To prevent electric shock, match wide blade of plug to wide slot and fully insert.
This Class B digital apparatus complies with Canadian ICES-003.

POUR LES CONSOMMATEURS CANADIENS

Pour éviter les chocs électriques, introduire la lame la plus large de la fiche dans la borne correspondante de la prise et pousser jusqu'au fond.
Cet appareil numérique de la classe B est conforme à la norme NMB-003 du Canada.

CONTENTS

INTRODUCTION

FEATURES	2
SUPPLIED ACCESSORIES	2
CONTROLS AND FUNCTIONS	3
Front panel.....	3
Front panel display	4
Rear panel	5

SETUP

CONNECTIONS	6
Connecting the AM and FM antennas	6
Connecting an amplifier	9
Controlling this unit with a remote control.....	9
Connecting the power supply cord	10
Turning on the power.....	10

OPERATIONS

TUNING	11
Automatic and manual tuning.....	11
Presetting stations	12
Selecting preset stations.....	14
Exchanging preset stations	14

ADDITIONAL INFORMATION

TROUBLESHOOTING	16
SPECIFICATIONS	18

INTRODUCTION

SETUP

OPERATIONS

ADDITIONAL
INFORMATION

FEATURES

- ◆ 40-station random access preset tuning
- ◆ Automatic preset tuning
- ◆ Multi-status station memory
- ◆ Direct PLL synthesizer tuning
- ◆ Preset station shifting capability (preset editing)
- ◆ Multi-functions for Radio Data System broadcast reception (U.K. and Europe models only)

• * indicates a tip for your operation.

• This manual is printed prior to production. Design and specifications are subject to change in part as a result of improvements, etc. In case of differences between the manual and product, the product has priority.

SUPPLIED ACCESSORIES

Please check that you received all of the following parts.

Indoor FM antenna

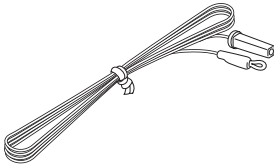

Audio pin cable

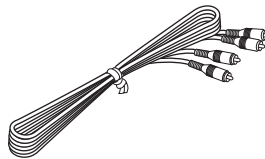

AM loop antenna

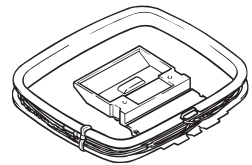

**Antenna adapter
(U.S.A. and Canada
models only)**

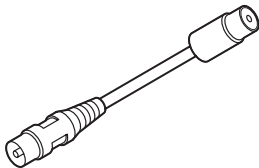

**75-ohm/300-ohm
antenna adapter
(U.K. model only)**

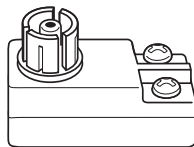

CONTROLS AND FUNCTIONS

Front panel

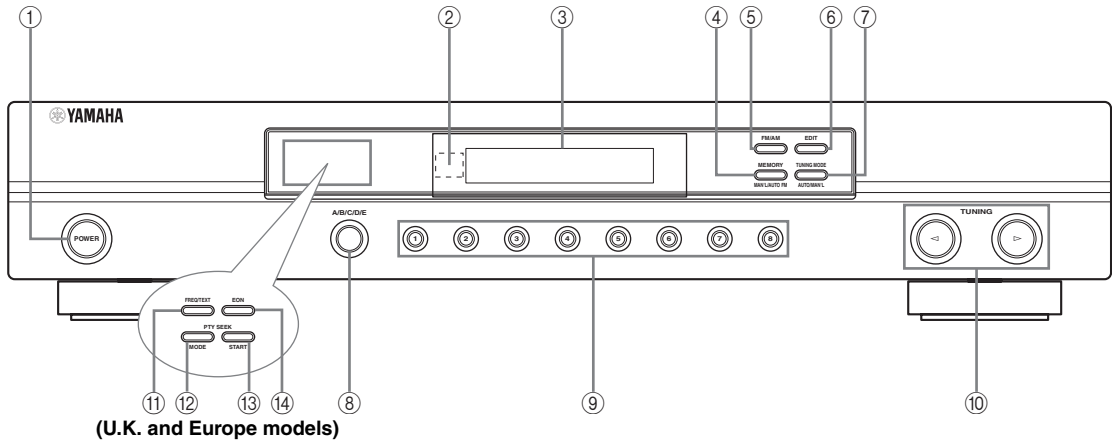

① POWER

Turns on or off the power of this unit.

② Remote control sensor

Receives signals from a remote control provided with a YAMAHA amplifier or receiver.

③ Front panel display

Shows information about the operational status of this unit (see page 4).

④ MEMORY (MAN'L/AUTO FM)

Stores a station in the memory (see page 13).
Hold down this button for more than 3 seconds to start automatic preset tuning (see page 12).

⑤ FM/AM

Press this button to switch the reception band between FM and AM.

⑥ EDIT

Exchanges preset station numbers (see page 14).

⑦ TUNING MODE (AUTO/MAN'L)

Switches between automatic tuning (AUTO indicator on) and manual tuning (AUTO indicator off).

⑧ A/B/C/D/E

Selects one of the 5 preset station groups (A to E).

⑨ Preset station buttons

Select a preset station number (1 to 8).

⑩ ◀ TUNING ▶

Selects a frequency.

- Press ◀ to tune into a lower frequency.
- Press ▶ to tune into a higher frequency.

■ U.K. and Europe models only

The Radio Data System tuning buttons numbered from ⑪ to ⑭ are only applicable to the U.K. and Europe models.

⑪ FREQ/TEXT

Press this button when the unit is receiving a Radio Data System station to cycle the display between the PS mode, PTY mode, RT mode, CT mode (if the station offers those Radio Data System data services) and/or the frequency display.

⑫ PTY SEEK MODE

Press this button to set the unit to the PTY SEEK mode.

⑬ PTY SEEK START

Press this button to begin searching for a station after the desired program type has been selected in the PTY SEEK mode.

⑭ EON

Press this button to select a radio program type (NEWS, INFO, AFFAIRS, SPORT) to tune in automatically.

Front panel display

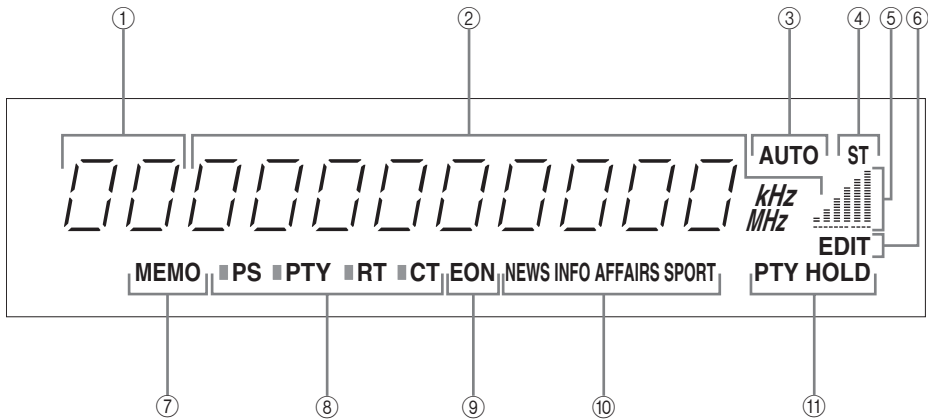

① Preset station indicator

Displays the group (A to E) and number (1 to 8) of the selected preset station.

② Station frequency display

Displays the band and frequency or information about the station being received.

③ AUTO indicator

Lights up to indicate that automatic tuning is possible.

④ ST (stereo) indicator

Lights up when this unit is receiving a strong signal for an FM stereo broadcast.

⑤ Signal-level meter

Indicates the signal level of the station being received. If multi-path interference is detected, the indication decreases.

⑥ EDIT indicator

Flashes to indicate that preset station exchange is possible. Lights up to indicate that preset station exchange was successful.

⑦ MEMO indicator

Flashes for about 5 seconds after MEMORY on the front panel is pressed. While the MEMO indicator is flashing, store the displayed station in the system memory by using A/B/C/D/E and one of the preset station buttons on the front panel.

■ U.K. and Europe models only

The indicators numbered from ⑧ to ⑪ are only applicable to the U.K. and Europe models.

⑧ Radio Data System indicators

The name(s) of the Radio Data System data offered by the currently received Radio Data System station light(s) up. The indicator on the left side of each name (the rectangular-shaped shaded area) lights up when the corresponding Radio Data System mode is selected.

⑨ EON indicator

Lights up when the Radio Data System station that offers the EON data service is being received.

⑩ Program type indicators

Indicate the selected radio program type (NEWS, INFO, AFFAIRS or SPORT) while this unit is in the EON mode.

⑪ PTY HOLD indicator

PTY HOLD lights up while searching for stations in the PTY SEEK mode.

Rear panel

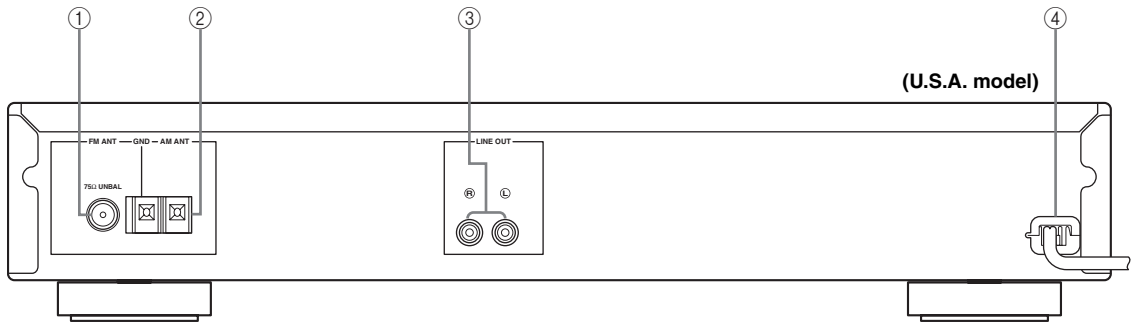

① FM ANT terminal

See page 6 for connection information.

② AM ANT terminal

See page 6 for connection information.

③ LINE OUT jacks

See page 9 for connection information.

④ AC power cord

Plug the power cord into an AC inlet after all connections are complete (see page 10).

■ Asia and General models only

The FREQUENCY STEP switch and VOLTAGE SELECTOR are only applicable to the Asia and General models.

FREQUENCY STEP switch

See page 8 for details.

VOLTAGE SELECTOR

See page 10 for details.

CONNECTIONS

CAUTION

Do not connect this unit or other components to the mains power until all connections are complete.

Connecting the AM and FM antennas

Both AM and FM indoor antennas are included with this unit. In general, these antennas should provide sufficient signal strength. Connect each antenna correctly to the designated terminals.

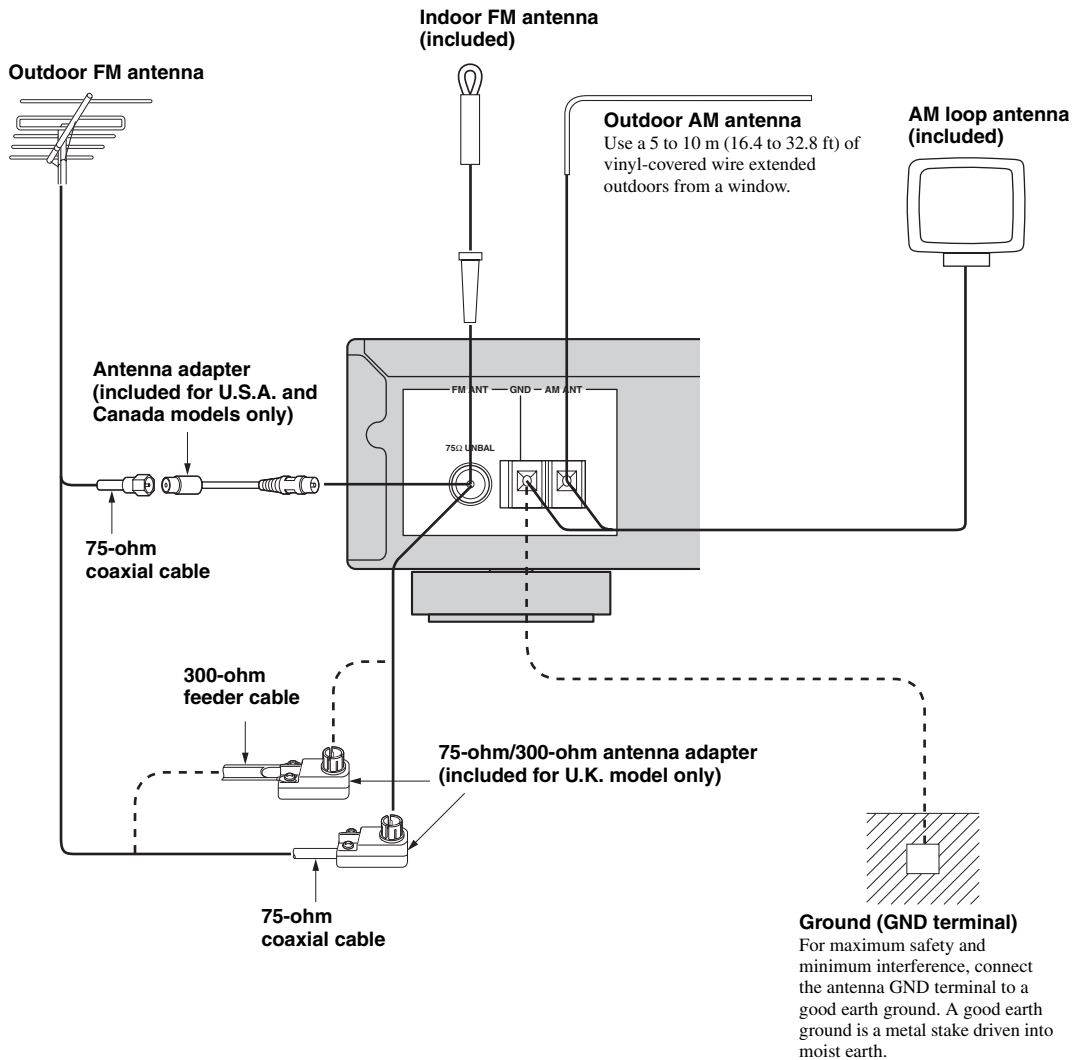

■ Connecting the AM loop antenna

1 Set up the AM loop antenna.

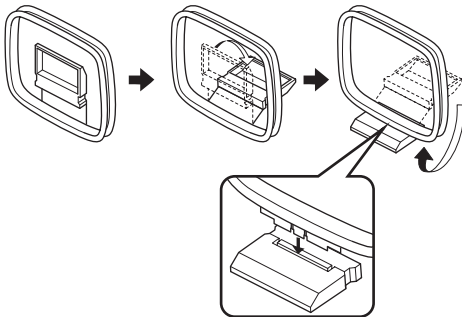

2 Press and hold the tab to insert the AM loop antenna lead wires into the AM ANT and GND terminals.

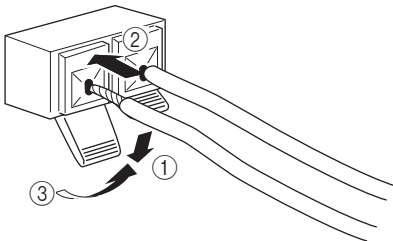

3 Orient the AM loop antenna for the best reception.

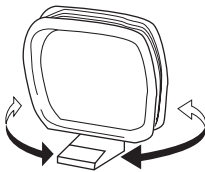

Notes

- The AM loop antenna should be placed away from this unit.
- A properly installed outdoor antenna provides clearer reception than an indoor one. If you experience poor reception quality, an outdoor antenna may improve the quality. It is recommended that you should connect a 5 to 10 m (16.4 to 32.8 ft) of vinyl-covered wire to the AM ANT terminal and extend it outdoors from a window. Consult the nearest authorized YAMAHA dealer or service center for more details about outdoor antennas.
- The AM loop antenna should always be connected, even if an outdoor AM antenna is connected to this unit.

■ Connecting the indoor FM antenna

Insert the rectangular end of the indoor FM antenna into the FM ANT terminal.

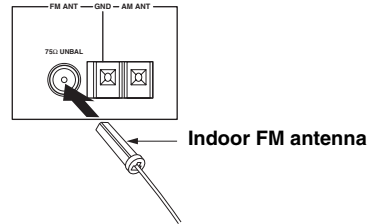

Notes

- A properly installed outdoor antenna provides clearer reception than an indoor one. If you experience poor reception quality, an outdoor antenna may improve the quality. Consult the nearest authorized YAMAHA dealer or service center about outdoor antennas.
- If you connect an outdoor FM antenna to this unit, do not connect the indoor FM antenna to this unit.

■ Connecting the outdoor FM antenna

If this unit is installed inside a steel building or at a great distance from the transmitter, it may be necessary to install an outside long wire antenna.

Use a 75-ohm/300-ohm antenna adapter (included for U.K. model only) or an antenna adapter (included for U.S.A. and Canada models only) for connections.

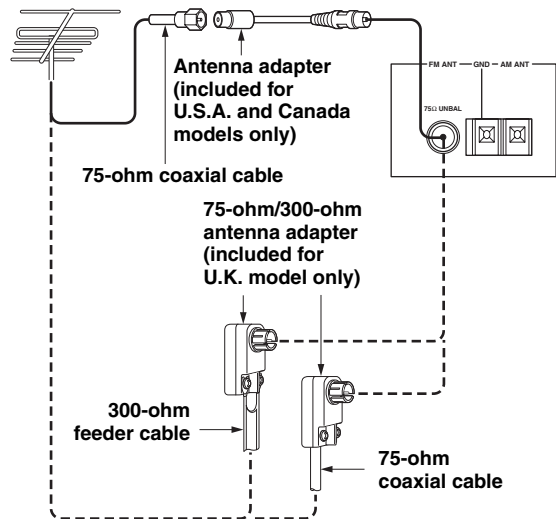

■ **Connecting a coaxial cable to the 75-ohm/300-ohm antenna adapter (included for U.K. model only)**

1 Open the cover of the included 75-ohm/300-ohm antenna adapter.

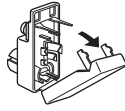

2 Cut the external sleeve of the 75-ohm coaxial cable and prepare it for connection.



3 Cut the lead wire and remove it.

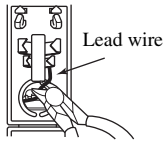

4 Insert the cable wire into the slot, and clamp it with pliers.

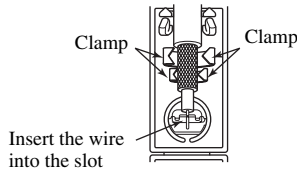

5 Snap the cover into place.

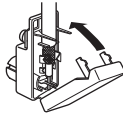

■ **Notes on the 75-ohm coaxial and the 300-ohm feeder cables**

Consult with your dealer or authorized service center about the best method of selecting and erecting an outdoor FM antenna. The choice of the feeder cable is also important. Flat ribbon-shaped twin-lead cable performs well electrically, and is cheaper and somewhat easier to handle when routing it through windows and around rooms. Coaxial cable is more expensive, does a much better job of minimizing interference, is less prone to the effects of weather and close-by metal objects, and is nearly as good a signal conductor as feeder cable, particularly for foam-type coaxial cables. Coaxial cable is somewhat more difficult to install at the point where the cable enters the building. If coaxial cable is selected, make sure the antenna is designed to be used with that type of cable.

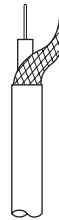

75-ohm coaxial cable

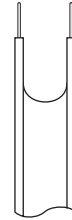

300-ohm feeder cable

Notes

- To minimize interference from automobile ignition, locate the antenna as far from heavy traffic as possible.
- Keep the feeder cable or coaxial cable as short as possible. Do not bundle or roll up excess cable.
- The antenna should be placed at least 2 meters (6.6 ft) from reinforced concrete walls or metal structures.

■ **FREQUENCY STEP switch (Asia and General models only)**

Because the interstation frequency spacing differs in different areas, set the FREQUENCY STEP switch on the rear panel of this unit according to the frequency spacing in your area.

- North, Central and South America: 100 kHz/10 kHz
- Other areas: 50 kHz/9 kHz

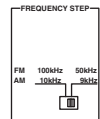

Before setting this switch, disconnect this unit's AC power plug from the AC wall outlet.

Connecting an amplifier

CAUTION

Do not connect this unit or other components to the main power until all connections between components are complete.

Note

Be sure to connect the left (“L”) and right (“R”) LINE OUT jacks to the corresponding (left and right) input jacks of the amplifier.

This unit (U.S.A. model)

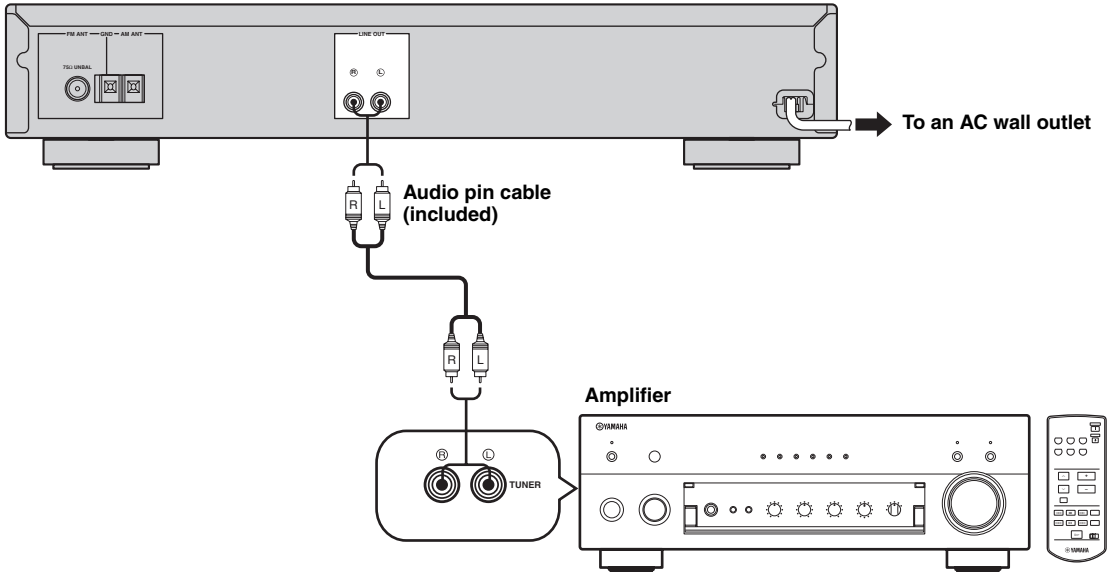

Controlling this unit with a remote control

This unit has a remote control sensor. It receives signals from a remote control provided with a YAMAHA amplifier or AV receiver.

Notes

- Do not place any large obstacles between the remote control and this unit.
- If the remote control sensor is directly illuminated by strong lighting (especially an inverter type fluorescent lamp), you may not be able to control this unit using the remote control. In this case, reposition this unit to avoid direct lighting.

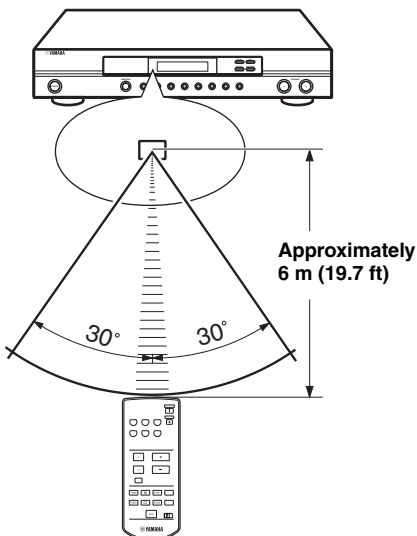

Connecting the power supply cord

■ Connecting the AC power cord

Plug the power cord into an AC wall outlet.

■ Memory back-up

The memory back-up circuit prevents the stored data from being lost. However, the stored data will be lost if this unit is turned off for more than one week even when the power cord is connected.

■ VOLTAGE SELECTOR (Asia and General models only)

The VOLTAGE SELECTOR on the rear panel of this unit must be set for your local main voltage BEFORE plugging into the AC main supply.

Voltages are 110-120/220-240 V AC, 50/60 Hz.

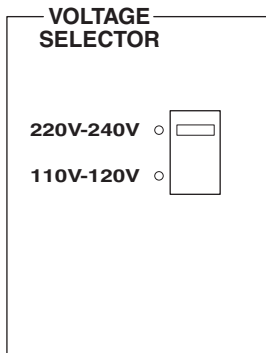

(Asia and General models)

Turning on the power

When all connections are complete, turn on the power of this unit.

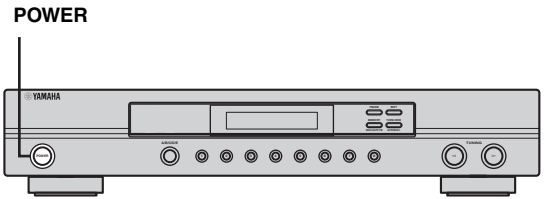

Press **POWER** to turn on the power of this unit.



TUNING

Automatic and manual tuning

There are 2 tuning methods; automatic and manual. Automatic tuning is effective when station signals are strong and there is no interference.

Automatic tuning

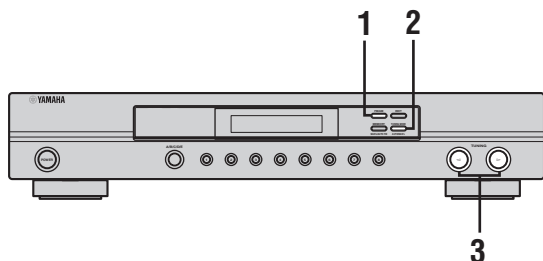

- 1 Press FM/AM to select the reception band. “FM” or “AM” appears in the front panel display.



- 2 Press TUNING MODE (AUTO/MAN'L) so that the AUTO indicator lights up in the front panel display.



- 3 Press TUNING </> once to begin automatic tuning.

Press > to tune into a higher frequency, or press < to tune into a lower frequency.

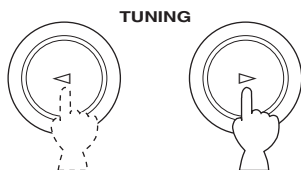

When tuned into a station, the frequency of the received station is shown in the front panel display. To search for another station, press TUNING </> once more.

Manual tuning

If the signal from the station you want to select is weak, tune into it manually. Manually tuning into an FM station will automatically switch the tuner to monaural reception to increase the signal quality.

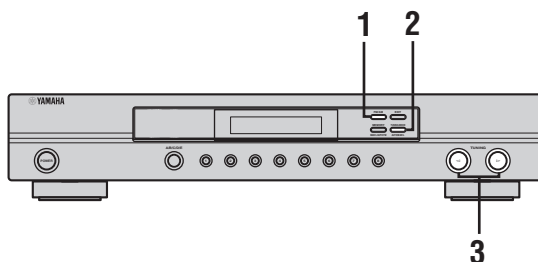

- 1 Press FM/AM to select the reception band. “FM” or “AM” appears in the front panel display.

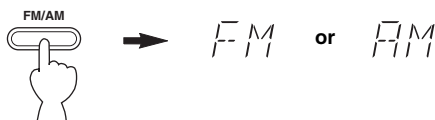

- 2 Press TUNING MODE (AUTO/MAN'L) so that the AUTO indicator disappears from the front panel display.

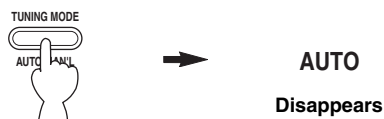

- 3 Press TUNING </> to tune into the desired station manually.

Hold down the button to continue searching.

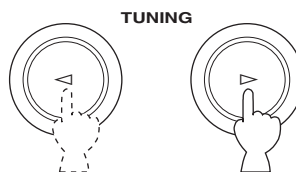

Notes

- If you tune into an FM station, it is automatically received in monaural mode to increase signal quality.
- When tuned into a station, the frequency of that station is shown in the front panel display.

Presetting stations

■ Automatically presetting FM stations

You can use the automatic preset tuning feature to store FM stations. This function enables this unit to automatically tune into FM stations with strong signals, and to store up to 40 (8 stations in 5 groups, A1 through E8) of those stations in order. You can then recall any preset station easily by selecting the preset station number.

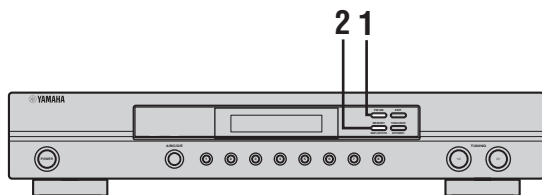

1 Press FM/AM to select the FM band.

“FM” appears in the front panel display.

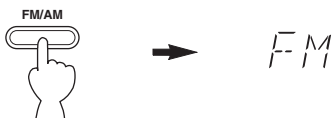

2 Press and hold MEMORY (MAN'L/AUTO FM) for more than 3 seconds.

The preset group and MEMO and AUTO indicators flash. Automatic presetting starts from the frequency currently displayed and proceeds toward the higher frequencies.

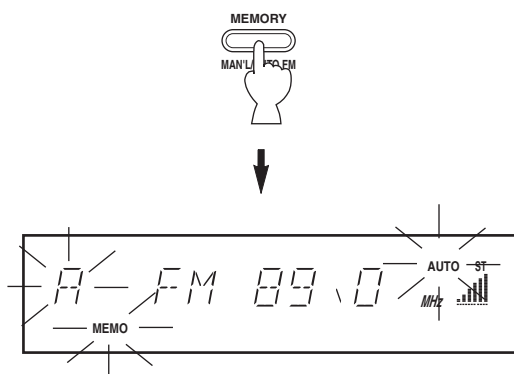

When automatic preset tuning is complete, the front panel display shows the frequency of the last preset station.

Notes

- Any stored station data existing under a preset number is cleared when you store a new station under that preset number.
- If the number of received stations does not reach 40 (E8), automatic preset tuning has automatically stopped after searching all stations.
- Only FM stations with sufficient signal strength are stored automatically by automatic preset tuning. If the station you want to store is weak in signal strength, tune into it manually and store it by following the procedure in “Manually presetting stations”.
- If no station is received using the automatic preset tuning method, “NOTHING” is displayed in the front panel display for about 3 seconds and the search ends.

Manually presetting stations

You can also store up to 40 stations (8 stations x 5 groups) manually.

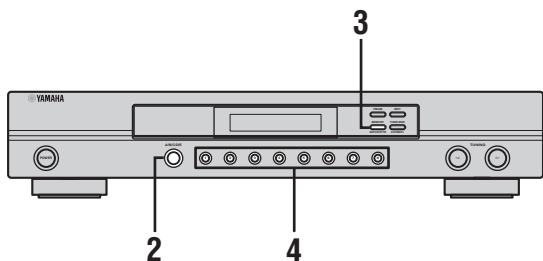

1 Tune into a station.

See page 11 for tuning instructions.

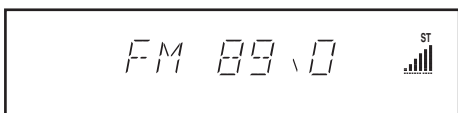

When tuned into a station, the front panel display shows the frequency of the station received.

2 Press A/B/C/D/E repeatedly to select a preset station group (A to E) in the front panel display.

The station group is displayed in the front panel display.

A/B/C/D/E

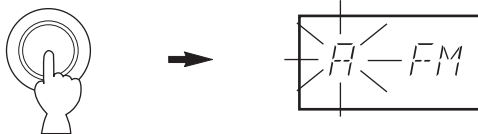

3 Press MEMORY (MAN'L/AUTO FM).

The MEMO indicator flashes for about 5 seconds.



4 Press the preset station number button (1 to 8) you want to store while the MEMO indicator is flashing.

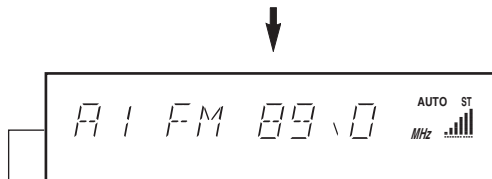

Shows the displayed station has been stored as A1.

5 Repeat steps 1 to 4 to store other stations.

Notes

- Any stored station data existing under a preset number is cleared when you store a new station under that preset number.
- The reception mode (stereo or monaural) is stored along with the station frequency.

Selecting preset stations

You can tune any desired station simply by selecting the preset station number under which it was stored.

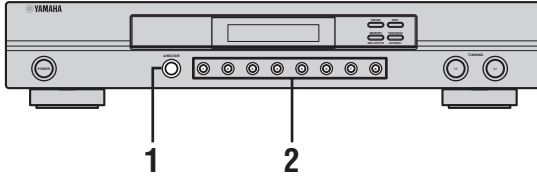

- 1 Press A/B/C/D/E repeatedly to select a preset station group (A to E) in the front panel display.

The station group is displayed in the front panel display.

A/B/C/D/E

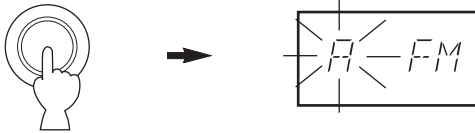

- 2 Press a preset station number button to select the preset station number (1 to 8).

The preset station number appears in the front panel display along with the station band and frequency.

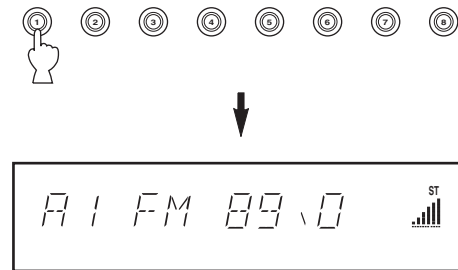

Note

In some cases, you may not be able to select a preset station that could be received using the automatic tuning method. This is due to the large volume of Program Identification (PI) data received along with the station.

Exchanging preset stations

You can exchange the assignment of two preset stations with each other. The example below describes the procedure for exchanging preset station "E1" with "A5".

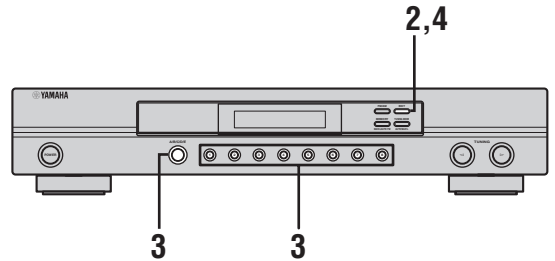

- 1 Select preset station "E1".
See "Selecting preset stations".

- 2 Press EDIT.

"E1" and the EDIT indicator flash in the front panel display.

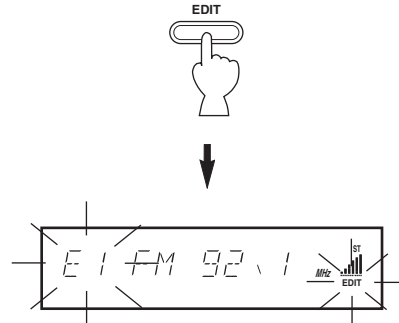

- 3 Select preset station "A5" using A/B/C/D/E and the preset station number buttons.

"A5" and the EDIT indicator flash in the front panel display.



4 Press EDIT again.

The stations stored at the two preset assignments are exchanged.

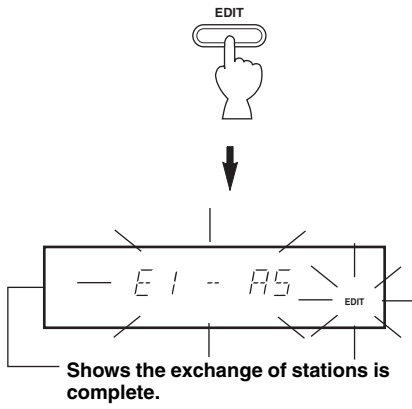

TROUBLESHOOTING

Refer to the chart below when this unit does not function properly. If the problem you are experiencing is not listed below or if the instruction below does not help, turn off the power of this unit, disconnect the power cord, and contact the nearest authorized YAMAHA dealer or service center.

■ Tuner

Problem		Cause	Remedy	Refer to page
FM	There are occasional crackling noises (especially in weak signal areas).	Noise resulting from motors, thermostats or other electrical equipment.	Position the FM antenna as high as possible away from roads and digital or high-frequency equipment. Use a coaxial cable. Attach a noise suppressor to the equipment causing the noise.	—
	FM stereo reception is noisy.	The characteristics of FM stereo broadcasts may cause this problem when the transmitter is too far away or the antenna input is poor.	Check the antenna connections. Try using a high-quality directional FM antenna.	6
			Set the TUNING MODE button to the manual tuning mode. Use the manual tuning method.	11
	The ST indicator flickers and reception is noisy.	Insufficient antenna input.	Use an antenna appropriate for the reception conditions in your area.	—
		The station is not tuned correctly.	Tune in the station once more.	11
	There is distortion, and clear reception cannot be obtained even with a good FM antenna.	There is multipath interference.	Adjust the antenna position to eliminate multipath interference.	—
	No stereo effect even with a stereo broadcast.	The TUNING MODE button is set to the manual tuning mode.	Press TUNING MODE repeatedly until "AUTO" lights up in the front panel display.	11
	The desired station cannot be tuned in with the automatic tuning method.	The signal is too weak.	Use a high-quality directional FM antenna.	7
Use the manual tuning method.			11	
Previously preset stations can no longer be tuned in.	The power cord has been disconnected from the AC outlet or the power of this unit has been turned off for more than one week.	Preset the stations again.	12	
AM	The desired station cannot be tuned in with the automatic tuning method.	The signal is weak or the antenna connections are loose.	Tighten the AM loop antenna connections and orient it for the best reception.	7
			Use the manual tuning method.	11
	There are continuous crackling and hissing noises.	Noise resulting from lightning, fluorescent lamps, motors, thermostats or other electrical equipment.	Move this unit further away from digital or high-frequency equipment. Use an outdoor antenna and a ground wire. This will help somewhat, but it is difficult to eliminate all noise.	—
	There are buzzing and whining noises.	There is interference from another station.		—
A TV set is being used nearby.		Move this unit away from the TV.	—	

■ General

Problem	Cause	Remedy
This unit fails to turn on when POWER is pressed.	The power cord is not connected or the plug is not completely inserted.	Connect the power cord firmly.
	This unit has been exposed to a strong external electric shock (such as lightning or strong static electricity).	Disconnect the power cord, plug it back in after 30 seconds, then use it normally.
A “humming” sound can be heard.	Incorrect cable connections.	Firmly connect the audio connection cord plugs. If the problem persists, the cables may be defective.
This unit does not operate properly.	The internal microcomputer has been frozen by an external electric shock (such as lightning or excessive static electricity) or by a power supply with low voltage.	Disconnect the AC power cord from the outlet and then plug it in again after about 30 seconds.

SPECIFICATIONS

AUDIO SECTION

- Output Level/Impedance (fixed)
 - FM (100% mod., 1 kHz)
 - [U.K. and Europe models] (40 kHz dev.) 500 mV/2.2 k Ω
 - [Other models] 900 mV/2.2 k Ω
 - AM (30% mod., 1 kHz)
 - [U.K. and Europe models] 200 mV/2.2 k Ω
 - [Other models] 150 mV/2.2 k Ω

FM SECTION

- Tuning Range
 - [U.S.A. and Canada models] 87.5 to 107.9 MHz
 - [Asia and General models] 87.5/87.50 to 108.0/108.00 MHz
 - [Other models] 87.50 to 108.00 MHz
- 50 dB Quieting Sensitivity (IHF) (100% mod., 1 kHz)
 - [U.S.A., Canada, General, China, Australia and Asia models only]
 - Mono 1.55 μ V (15.1 dBf)
 - Stereo 21 μ V (37.7 dBf)
- Usable Sensitivity (DIN)
 - [U.K. and Europe models only]
 - Mono (S/N 26 dB) 0.9 μ V
 - Stereo (S/N 46 dB) 24 μ V
- Image Response Ratio
 - [U.S.A., Canada, General and China models] 40 dB
 - [Other models] 80 dB
- IF Response Ratio 70 dB
- Spurious Response Ratio
 - [U.S.A., Canada, General and China models] 60 dB
 - [Other models] 70 dB
- Alternate Channel Selectivity
 - [U.S.A., Canada, General and China models only] 85 dB
- Selectivity (two signals, 40 kHz dev., \pm 300 kHz)
 - [U.K., Europe, Australia and Asia models only] 70 dB
- Signal to Noise Ratio (IHF)
 - [U.S.A., Canada, General and China models]
 - Mono 82 dB
 - Stereo 76 dB
 - [U.K., Europe, Australia and Asia models] (DIN-weighted)
 - Mono (40 kHz dev.) 75 dB
 - Stereo (40 kHz dev.) 70 dB
- Harmonic Distortion (1 kHz)
 - [U.K. and Europe models]
 - Mono/Stereo (40 kHz dev.) 0.1%/0.2%
 - [Other models]
 - Mono/Stereo 0.1%/0.2%
- Stereo Separation (1 kHz)
 - [U.K. and Europe models] (40 kHz dev.) 50 dB
 - [Other models] 50 dB
- Frequency Response (30 Hz to 13 kHz) 0 \pm 0.5 dB

AM (MW) SECTION

- Tuning Range
 - [U.S.A., Canada and General models] 530 to 1710 kHz
 - [Other models] 531 to 1611 kHz
- Usable Sensitivity 200 μ V/m
- Selectivity 32 dB
- Signal to Noise Ratio 50 dB
- Image Response Ratio 40 dB
- Spurious Response Ratio 50 dB
- Harmonic Distortion 0.3%

AM (LW) SECTION

(U.K. and Europe models only)

- Tuning Range 153 to 288 kHz
- Usable Sensitivity 400 μ V/m
- Selectivity 32 dB
- Signal to Noise Ratio 50 dB
- Image Response Ratio 40 dB
- Spurious Response Ratio 50 dB
- Harmonic Distortion 0.3%

GENERAL

- Power Supply
 - [U.S.A. and Canada models] AC 120 V, 60 Hz
 - [Australia model] AC 240 V, 50 Hz
 - [U.K. and Europe models] AC 230 V, 50 Hz
 - [Asia and General models] ... AC 110–120/220–240 V, 50/60 Hz
 - [China model] AC 220 V, 50 Hz
- Power Consumption 7 W
- Dimensions (W x H x D) 435 x 86 x 271 mm
(17-1/8" x 3-3/8" x 10-21/32")
- Weight 3.2 kg (7 lbs. 1 oz.)

* Specifications are subject to change without notice.



This product mainly uses lead-free solder.

© 2005 YAMAHA CORPORATION All rights reserved.

YAMAHA ELECTRONICS CORPORATION, USA 6660 ORANGETHORPE AVE., BUENA PARK, CALIF. 90620, U.S.A.
YAMAHA CANADA MUSIC LTD. 135 MILNER AVE., SCARBOROUGH, ONTARIO M1S 3R1, CANADA
YAMAHA ELECTRONIK EUROPA G.m.b.H. SIEMENSSTR. 22-34, 25462 RELINGEN BEI HAMBURG, GERMANY
YAMAHA ELECTRONIQUE FRANCE S.A. RUE AMBROISE CROIZAT BP70 CROISSY-BEAUBOURG 77312 MARNE-LA-VALLEE CEDEX02, FRANCE
YAMAHA ELECTRONICS (UK) LTD. YAMAHA HOUSE, 200 RICKMANSWORTH ROAD WATFORD, HERTS WD18 7GQ, ENGLAND
YAMAHA SCANDINAVIA A.B. J A WETTERGRENS GATA 1, BOX 30053, 400 43 VÄSTRA FRÖLUNDA, SWEDEN
YAMAHA MUSIC AUSTRALIA PTY, LTD. 17-33 MARKET ST., SOUTH MELBOURNE, 3205 VIC., AUSTRALIA

YAMAHA CORPORATION
Printed in Malaysia ◀ WG00970